



Client \_\_\_\_\_ Quantity \_\_\_\_\_  
 Project \_\_\_\_\_ Position \_\_\_\_\_

## Master 700 lt cabinet

**Model:** A70/1B

**Cod:** A14070600101

### Technical data

<b>Gross capacity:</b>	601 lt
<b>Temperature range:</b>	-18°-22°C
<b>Refrigerant unit:</b>	Plug-In
<b>Energetic class:</b>	C
<b>Energy efficiency index:</b>	43,6
<b>Annual consumption:</b>	1609 kW/h annum
<b>24h consumption:</b>	4,408 kW/h/24h
<b>Climate class:</b>	5
<b>Cooling gas:</b>	R290
<b>Defrost:</b>	Hot gas
<b>Valve:</b>	Supplied standard with solenoid
<b>Dimensions:</b>	740×815×2085 mm
<b>Packing dimensions:</b>	835×930×2250 mm
<b>Gross weight:</b>	150 Kg
<b>Voltage:</b>	220-240 V - 50 Hz
<b>Total rate:</b>	810 W
<b>Absorbed Current:</b>	3,7 A
<b>Cooling capacity:</b>	453 W*
<b>*:</b>	Evap. -30°C Cond. +55°C

### Features

<b>Standard equipment:</b>	3 slides for GN2/1 shelves, 3 plastic coated GN2/1 shelves, lock with key, LED lighting
<b>Control:</b>	Electronic, display flush with the panel
<b>Doors:</b>	1 door, self-closing with a 105° stop, right hinged
<b>Door gasket:</b>	Magnetic, triple chamber and easily replaceable
<b>Insulation:</b>	75 mm thickness - CFC/HCFC free
<b>Exterior/interior finishing:</b>	Interno/esterno in acciaio inox AISI 304; schiena esterna, fondo e interno vano tecnico in acciaio galvanizzato/colaminato
<b>Inner corners:</b>	Rounded for easy cleaning and ensuring maximum hygiene
<b>Handle:</b>	Stainless steel AISI 304, 2 mm thick
<b>Racks and slides:</b>	Acciaio inox AISI 304
<b>Feets:</b>	Stainless steel AISI 304, adjustable h 100-150 mm

**COSMO - wi-fi control**

Cosmo is the innovative wi-fi technology that allows to connect all Coldline appliances in the kitchen and monitor them constantly from your smartphone. Connect Master cabinets to a Cosmo hub (MODI, VISION or LEVTRONIC) and from the app you can check the operating conditions of each machine in real time and receive any alerts in the event of power cuts or improper personnel interventions.



**Technical draw**

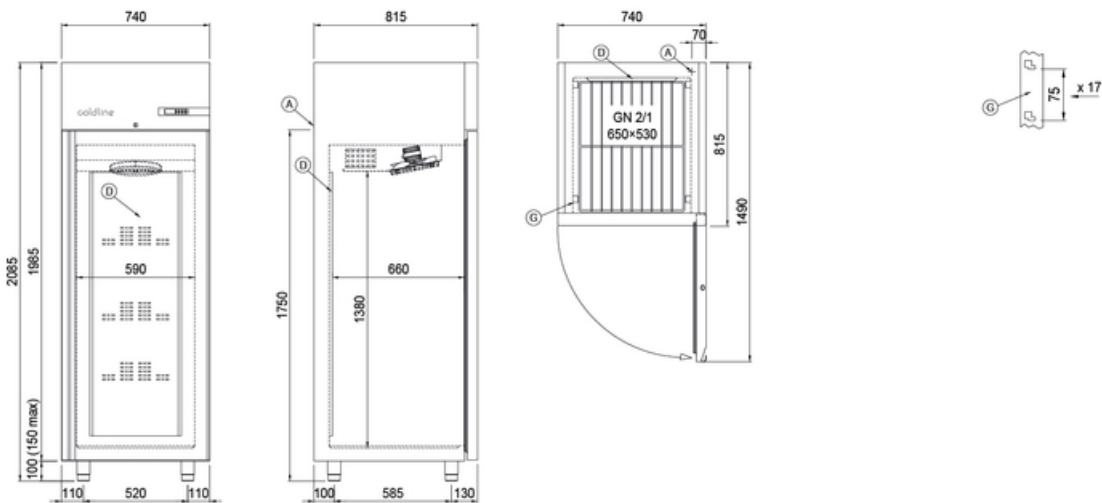

- A: Power supply cable outlet
- G: Racks pitch

- D: Airflow conveyor

In order to constantly offer the best possible products we reserve the right to make changes on technical specifications without incurring any obligation for equipment previously or subsequently sold.